

***TECHNICAL  
INFORMATION***

---

**CITIZEN QUARTZ  
Cal.No.914※※**

 **CITIZEN**

## 2. MAIN FEATURES

### 1) Full-dress calculator function

The calculator performs a number of applied calculations. Among them are the four rules of arithmetic (addition, subtraction, multiplication and division), extraction of the square root, automatic multiplication and division of constant, square, power, reciprocal, memory, function, commutation, factorial, statistics calculations and others.

### 2) Electronic (IC) switch for calculator ON/OFF

The calculator is turned ON with the first push of SW switch, and turned OFF with the second push of the switch. The calculator is turned OFF automatically in about 3 minutes and 30 seconds after completion of the button operation, which is especially effective in case the operator forgets to turn OFF the calculator after use.

### 3) Constant display of time

The watch displays "hour", "minute" and "second" constantly, and "month" and "date" are displayed instead of the time through a switch operation.

### 4) Automatic correction of calendar display

The "month" and "date" can be corrected and set automatically at the end of every month except for a leap year.

### 5) Built-in internal illumination lamp

An internal illumination lamp is built in the watch to facilitate an easy readout of the time even in a dark place.

### 6) Easy-to-disassemble/assemble movement

The number of the component parts is reduced extremely to facilitate an easy disassembly and assemble of the movement.

### 7) Continuous operation of about 3 years

Thanks to the newly developed matrix LC display system, the watch and calculator operates continuously for about 3 years on just a single unit of small-size silver oxide power cell.

## 1. OUTLINE

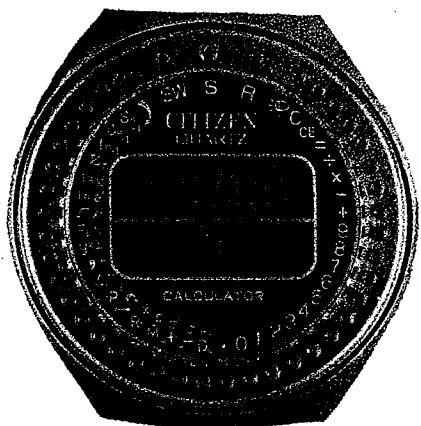

This is a highly accurate digital quartz crystal watch (liquid crystal display system) combined with a full-dress calculator. It is capable of various kinds of operations including even a functional equation, etc.

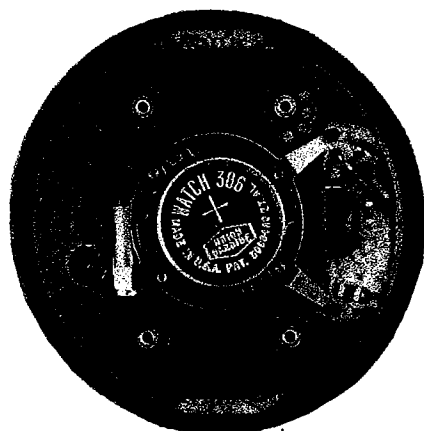

**Movement  
(Power cell side)**



**Movement  
(LC display panel side)**

## 4) How to use calculator

1. With push of switch button (SW),  is displayed on the calculator display window.
2. The button must be pushed lightly. An excessive pushing force may cause a fault to the calculator.
3. The disappearance of the display in the course of calculation indicates that a calculation is being carried out inside the calculator. So the calculator must be operated while confirming the display existence.
4. Due to a floating display system, the digits after the 9th (including 9th digits) are not registered in case a figure register of 8 digits or more is carried out.

Ex.) Registering of 1 2 3 4 5 6 7 8 9:

1 2 3 4 5 6 7 8 9 → 1 2 3 4 5 6 7 8

5. The figure register is limited up to 2 digits at the exponent part, so last 2 digits are registered in case a figure register of 3 digits or more is carried out.

Ex.) Registering of  $123 \times 10^{456}$

1 2 3  4 5 6 → 1 2 3      5 6

└──────────┘
└──────────┘  
 Mantissa part                  Exponent part

6. In case the calculations are carried out continuously, never fail to push the clear (C) button and confirm  display prior to execution of the succeeding calculation.
7. In case the buttons for the four rules of arithmetic ( $\oplus$ ,  $\ominus$ ,  $\otimes$ ,  $\oslash$ ) are pushed mistakenly, push the correct button immediately. In this case, the buttons pushed later become valid.
8. When the calculation is finished, push the switch button (SW) to make the display disappear. The calculator is turned OFF automatically in 3 minutes and 30 seconds after completion of the calculation, which is especially effective in case you forget to push (SW) button after the use of the calculator.
9. The button operation is possible with your fingers. However, the buttons are operated more smoothly if the accessory pushing tool, a mechanical pencil (with the lead pushed in) or the like is used. Avoid using a tool with a sharp tip, because it may damage the button.

### 3. HANDLING INSTRUCTIONS

#### 1) How to read time and calendar

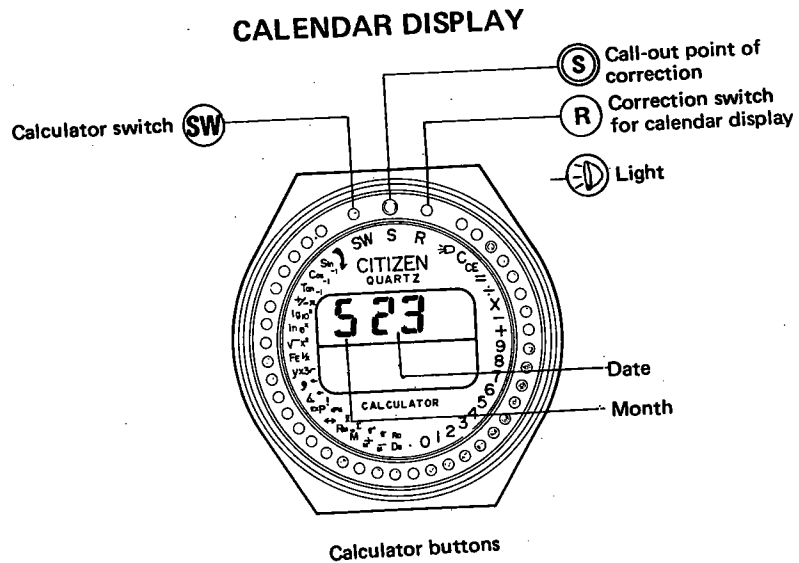
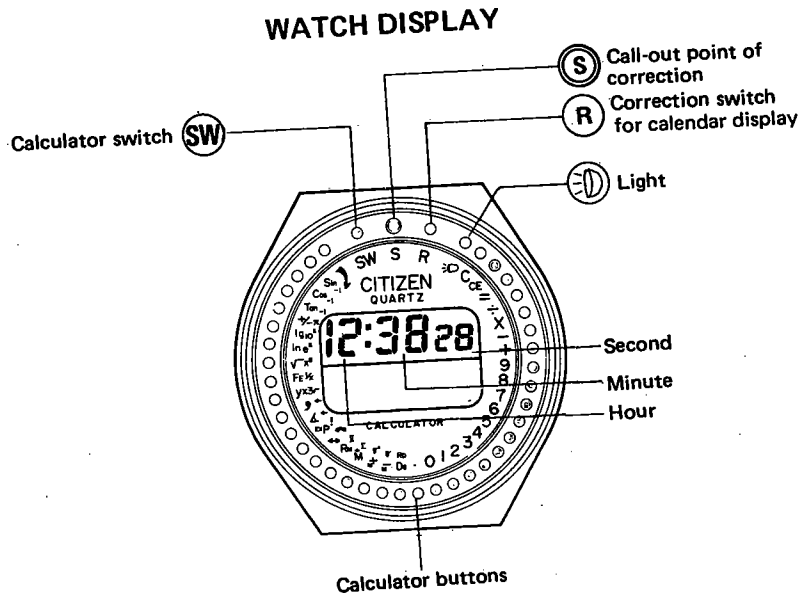

2) How to switch functions

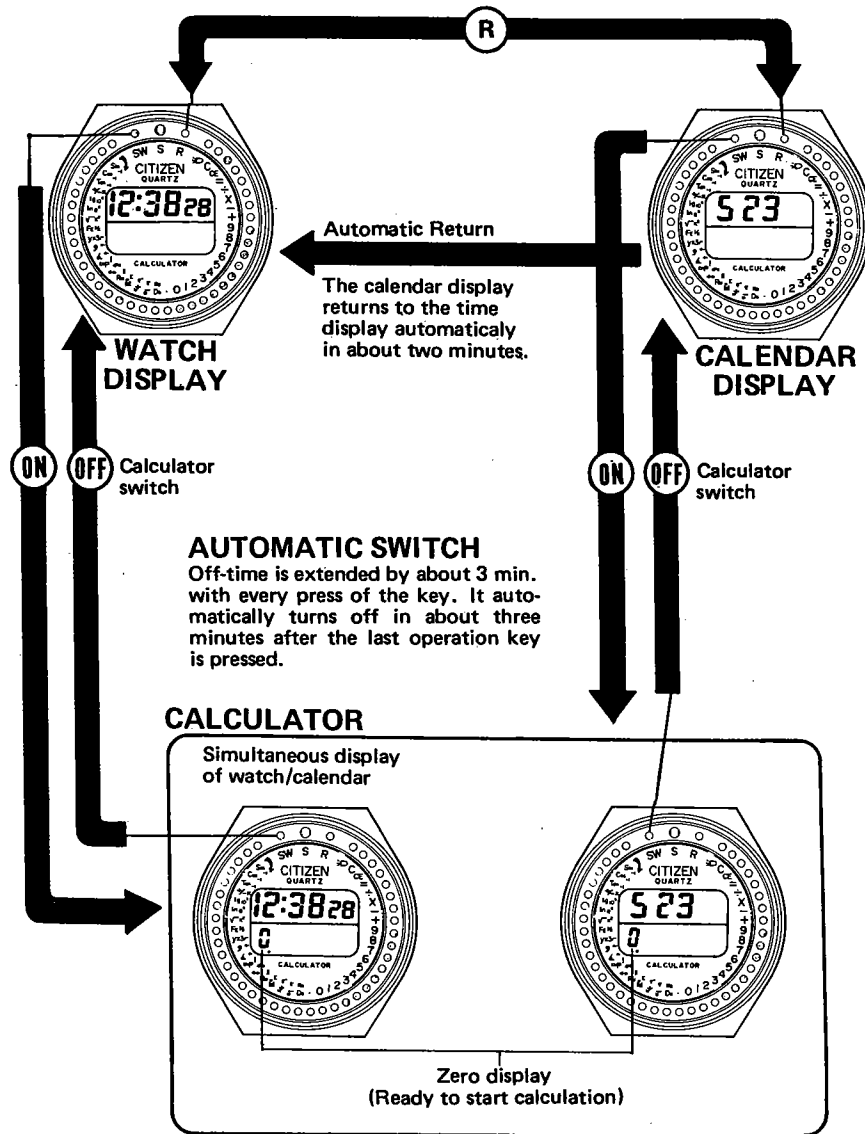

3) How to set time and calendar

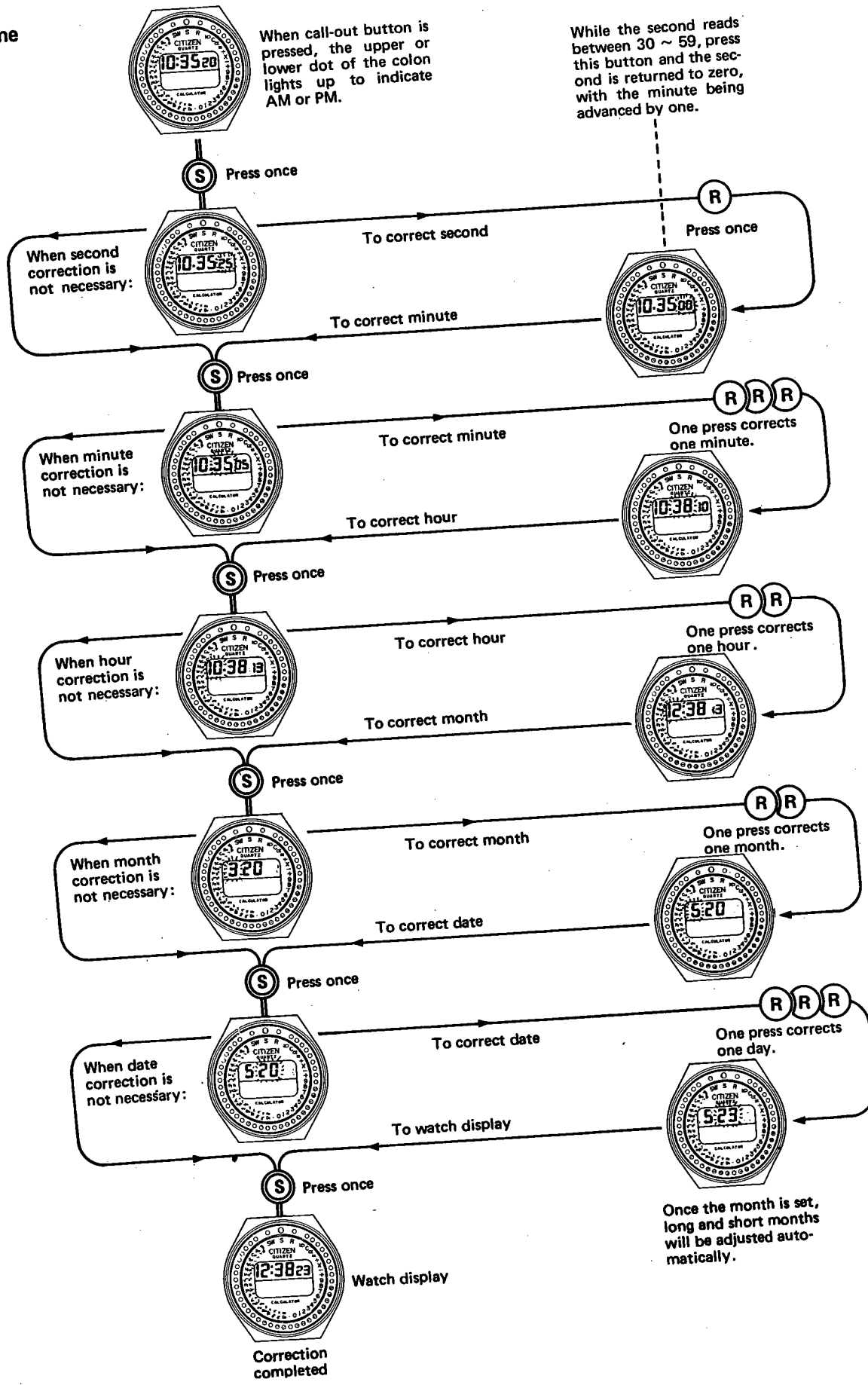

| (Keys)         | (Names)                        | (Function/Operation)  |
|----------------|--------------------------------|---|
| $\pm$          | Sign change button             | Pushed to invert the code of the displayed figure register. When pushed after $\text{EXP}$ button, the code at the exponent part is inverted. |
| $\pi$          | Pi button                      | For registering pi ( $\pi$ ). The 8 digits of pi (3.1415926) are registered automatically.  |
| $\lg$          | Common logarithm button        | For obtaining a logarithm with "10" as the base.  |
| $10^x$         | Common exponent button         | For obtaining the power with "10" as the base.  |
| $\ln$          | Natural logarithm button       | For obtaining a logarithm with e ( $\approx 2.7182818 \dots$ ) as the base.   |
| $e^x$          | Natural exponent button        | For obtaining the power of e.   |
| $\sqrt{\quad}$ | Root button                    | For obtaining a square root.  |
| $x^2$          | Square button                  | For carrying out a square calculation.  |
| $F_E$          | Effective 3-digits call button | Pushed to call for effective 3 digits which are not displayed when an exponent is registered.   |

Ex.) Registering of  $12345678 \times 10^{12}$ :

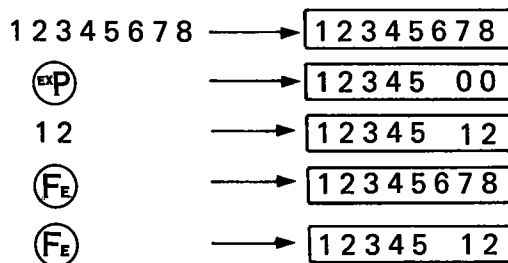

|                   |   |  |
|-------------------|---|--|
| $1/x$             | Reciprocal button                         | For obtaining a reciprocal of the displayed figure register.   |
| $y^x$             | Power button                              | For obtaining the power ( $x$ -power of $y$ ).   |
| $\sqrt[3]{\quad}$ | Cube root button                          | For obtaining the cube root.   |
| $\text{DMS}$      | Degree, minute & second conversion button | Pushed to convert the degree, minute and second (a 60-notation number is converted into a decimal number). |

Ex.) Conversion of  $3^\circ 12' 36''$  into a decimal:

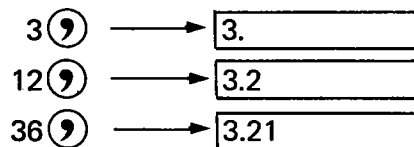



## 4)-1. Descriptions for button symbols

| (Key) | (Names)                              | (Function/Operation)   |
|-------|--------------------------------------|--|
|       | Switch button                        | Power ON/OFF switch of calculator.   |
|       | Clear button                         | Clears off all figure register and calculation orders except for the memory contents.  |
|       | Clear entry button                   | Corrects the buttons pushed mistakenly.<br>(For the four rules of arithmetic, the miss-push of the buttons can be corrected by pushing the correct buttons continuously. The buttons pushed later become valid.) |
|       | Equal button                         | For obtaining answers of the four rules of arithmetic and other calculations.  |
|       | Buttons for four rules of arithmetic | For carrying out the four rules of arithmetic.   |
|       | Figure register buttons              | Pushed from the upper digits to register figures.  |
|       | Decimal button                       | Pushed to register the decimal point.  |
|       | Right-row call button                | Pushed to designate the second function (inside function) of the button featuring two functions, prior to operation of those buttons.  |

Ex.) Calculation of  $12x^2$  :









$$12 \left( \text{Right-row call} \right) x^2 \longrightarrow 144$$

Calculation of  $\text{Sin}^{-1}0.5$ :

$$\text{Sin} \left( \text{Right-row call} \right) 5 \left( \text{Right-row call} \right) \left( \text{Sin}^{-1} \right) \longrightarrow 30$$

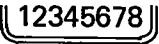
- \* The designation of the function returns to the left row automatically when the second function button is once pushed.
- \* In case no button is pushed, the first function (outside function) is designated.
- \* The button is reversible. When the button is pushed mistakenly, push this button again to designate function.
- \* "D<sub>G</sub> ↔ R<sub>D</sub>" switching is impossible with this button.

|  |                    |                               |
|--|--------------------|-------------------------------|
|  | Sine button        | For obtaining a sine.         |
|  | Arc-sine button    | For obtaining an arc-sine.    |
|  | Cosine button      | For obtaining a cosine.       |
|  | Arc-cosine button  | For obtaining an Arc-cosine   |
|  | Tangent button     | For obtaining a tangent.      |
|  | Arc-tangent button | For obtaining an arc-tangent. |

| (Keys)  | (Names)                              | (Function/Operation)  |
|---|--------------------------------------|---|
|    | Population standard deviation button | For obtaining the population standard deviation for the data which is put in when a statistics calculation is carried out.  |
|    | Degree button                        | Pushed to express the scale of angles in degree, minute and second for the trigonometric function or the coordinates conversion.  |
|    | Radian button                        | <p>"Radian" is an angle which is expressed in relation with the arc and the center angle of a circle, which is called "circular measure". This button is pushed to express the register or the calculation result in the radian unit.</p> <ul style="list-style-type: none"> <li>* With operation of  button, the angular unit starts always at "D<sub>G</sub>" state.</li> <li>* The unit switch of "D<sub>G</sub> ↔ R<sub>D</sub>" is performed with every push of "D<sub>G</sub> ↔ R<sub>D</sub>" button, regardless of  button (call button for the right row). The switched state is kept until "D<sub>G</sub> ↔ R<sub>D</sub>" button is pushed next.</li> </ul> |
|    | Display window                       | <p>Displays the register figures or the calculation result.</p> <ul style="list-style-type: none"> <li>* 8 digits are usually displayed. In case the absolute value of a calculation result is "0", "1 ~ 99999999" or less than "1" down to the 7th decimal plate, the register is displayed through a floating decimal point system. The registers other than the above are switched automatically to an exponent display.</li> </ul>  |
|  | Memory mark                          | Displayed at the upper right of the mantissa part when the figure register is memorized in the memory.  |
|  | Minus mark                           | Displayed at the right of the display part when the display register is negative at the mantissa part, and displayed at the left of the exponent part when the exponent part is negative respectively.  |
|  | Overflow error                       | An error mark is displayed at the right of the display part in case the calculation result exceeds the calculation range.   |

| (Key) | (Names)                                      | (Function/Operation)   |
|-------|--|--|
|       | Degree conversion button                     | Pushed to convert the degree into degree, minute and second.   |
|       | Polar coordinates conversion button          | Pushed to convert the vertical-cross coordinates into the polar coordinates.   |
|       | Vertical-cross coordinates conversion button | Pushed to convert the polar coordinates into the vertical-cross coordinates.   |
|       | Exponent register button                     | Pushed to have a figure register for the exponent part.<br>Ex.) Registering of $1.2 \times 10^{23}$ :<br>$1 \cdot 2 \text{ [exp]} 23 \rightarrow \boxed{1.2 \quad 23}$<br>Registering of $2.3 \times 10^{-34}$ :<br>$2 \cdot 3 \text{ [exp]} 34 \text{ [1/2]} \rightarrow \boxed{2.3 \quad -34}$ |
|       | Factorial button                             | For obtaining a factorial.   |
|       | Register conversion button                   | Pushed to replace the display register (X register) with the register inside the calculator (Y register).  |
|       | Statics calculation call button              | Pushed to carry out a statistics calculation.<br>* The set mark (—) is displayed with push of  button, and the register inside the calculator including memory and the calculation orders are all cleared off.   |
|       | Recall memory button                         | Pushed to call for the register which is memorized in the memory.  |
|       | Average value button                         | For obtaining the average value for the data which is put in when a statistics calculation is carried out.   |
|       | Memory register button                       | Pushed to have a register into the memory.<br>* When pushed after  button, the memory is cleared off.  |
|       | Sigma button                                 | Pushed to obtain the sum total of the data which is put in when carrying out a statistics calculation.   |
|       | Memory addition button                       | Pushed to add the display register and the calculator result to the memory.  |
|       | Sample standard deviation button             | Pushed to obtain the standard deviation for the data which is put in when carrying out a statistics calculation.   |
|       | Memory subtraction button                    | Pushed to subtract the display register or the calculation result from the memory.   |

## 5. SPECIFICATIONS

|                             |  |
|-----------------------------|--|
| Caliber No.                 | 9140A  |
| Type                        | Digital-type quartz crystal watch with LC display  |
| Movement                    | Size : 38.0 mm $\phi$<br>Thickness : 6.67 mm   |
| Oscillation                 | 32,768 Hz  |
| Accuracy                    | $\pm 10$ sec./month in normal temperature  |
| Display method              | FE twist type nematic liquid crystal   |
| information                 | <ul style="list-style-type: none"> <li>● Constant digital display of "hour", "minute" and "second"</li> <li>● "Month" and "date" displayed by switching operation</li> <li>● 8-digit display of calculator through matrix driving</li> </ul> <p>Calculations possible: Decimal point, four rules of arithmetic (addition, subtraction, multiplication &amp; division), extraction of the square, continuous operation, automatic constant multiplication &amp; division, square, power, reciprocal, memory, function, commutation, factorial, statistics, etc.</p> |
| Display correction          | Independent correction for each digit by push-buttons  |
| Effective temperature range | 0°C ~ +50°C (+32°F ~ +122°F)   |
| Integrated circuit          | C/MOS-LSI, 3 units (1 for watch, 2 for calculator)   |
| Additional mechanisms       | <ul style="list-style-type: none"> <li>● Calculator (with electronic switch)</li> <li>● Automatic calendar correction at the end of each month</li> <li>● Built-in internal illumination lamp</li> </ul>   |
| Power cell                  | <p>Small-size silver oxide power cell (280-21)</p> <p>Voltage : 1.5V</p> <p>Capacity : 120 mAH</p> <p>Size : 11.6 mm<math>\phi</math> x 4.2 mm</p> <p>Life : 3 years approx.<br/>(5 sec. lamp lighting &amp; 10 min. calculator operation per day)</p>   |



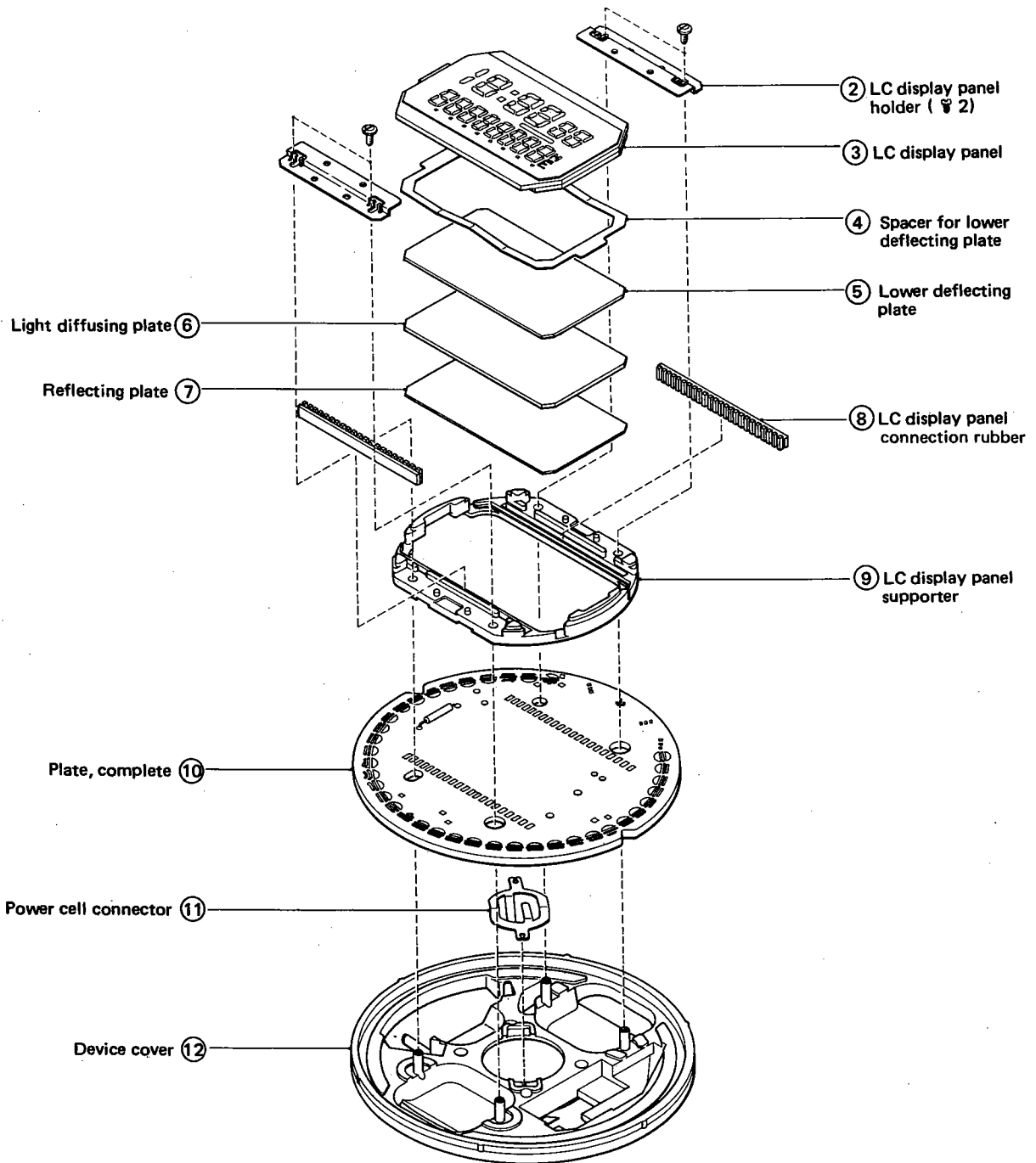

Every genuine Citizen deflecting plate is covered with vinyl sheet in view of protection of the plate against scratches or stains. Therefore, when replacing the deflecting plate with new one, first remove the vinyl cover.

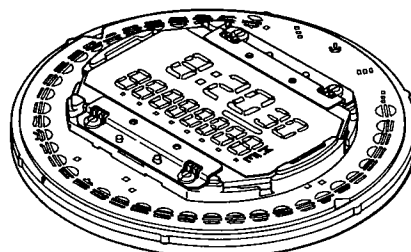

## 6. DISASSEMBLY AND ASSEMBLY OF MOVEMENT

- Disassembling procedure: ① → ⑫
- Assembling procedure: ⑫ → ①
- The number of screws necessary for parts is shown like ( ④ 1 )

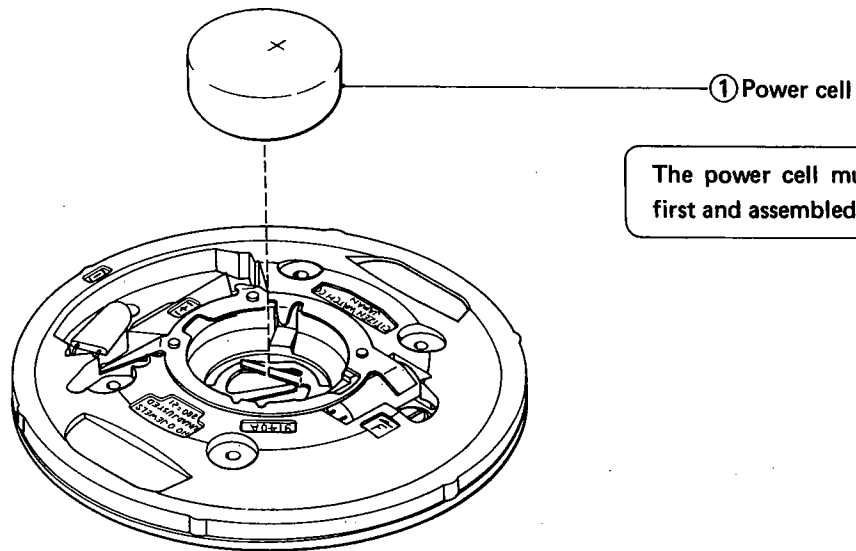

The power cell must be disassembled first and assembled last.

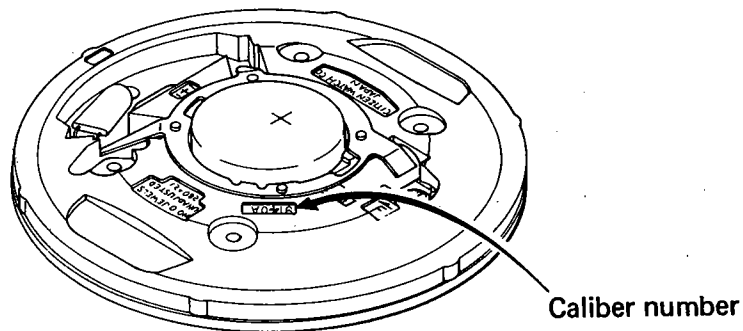

Avoid washing the electronic parts.

Remove dust or stains on the contact sections since they may deteriorate good conductivity. Lubrication for the movement is unnecessary.

(Note) When incorporating the glass, the inner diameter of the bezel complete must be supported by the lower end-piece after removal of the movement. In case the inner diameter is held by other objects, the bezel complete may have some strains.

(Note) After removal of the movement, the bezel complete is incorporated. The case center body must be supported by the lower end-piece.

① When removing the glass or tightening the caseback, the lower end-piece must be set as shown in the right figure.

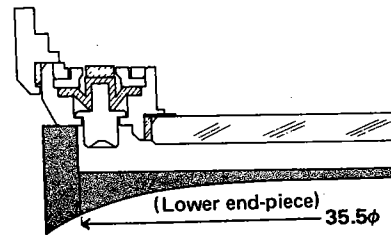

② When removing the bezel complete, the lower end-piece must be set as shown in the right figure.

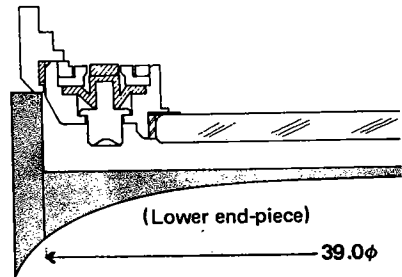

③ When incorporating the glass, the lower end-piece must be set as shown in the right figure.

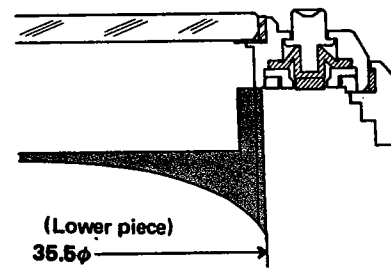

④ When incorporating the bezel complete, both the upper and lower end-pieces must be set as shown in the right figure.

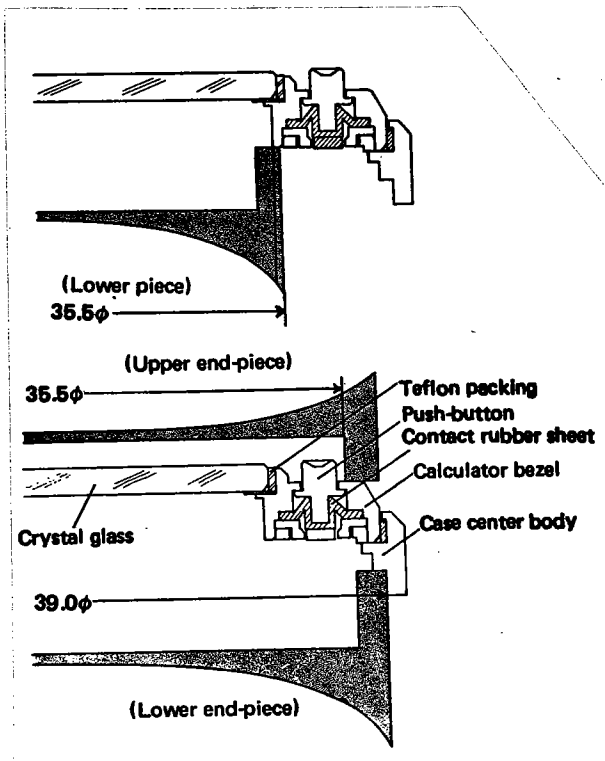



**■ NOTES**

- 1. Handling of lower deflecting plate and reflecting plate:**  
In order to protect damage or stains, use fingerstalls or bamboo tweezers and hold the extreme edge of the plate when handling the lower deflecting plate and reflecting plate.
- 2. Handling of LC display panel connection rubber:**  
The LC display panel connection rubber functions to perform an electrical conduction between the plate and LC display panel. In this respect, conduct an immediate replacement of the rubber if it loses elasticity or is extremely stretched out to ensure a sufficient contact with the LC display panel supporter.
- 3. The plate of this watch is made of ceramics so that take good care not to cause cracks or flaws on it. Although a special protective treatment is applied on the plate, finger prints or flaws caused by the use of a metal tweezers may deteriorate the plate function. Therefore, use fingerstalls or bamboo tweezers when handling the plate.**

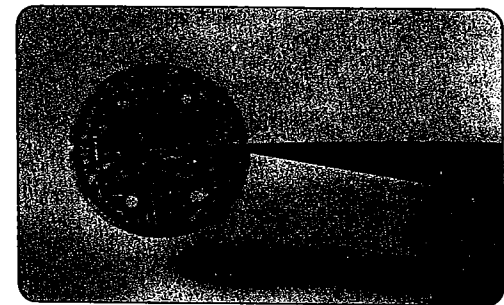
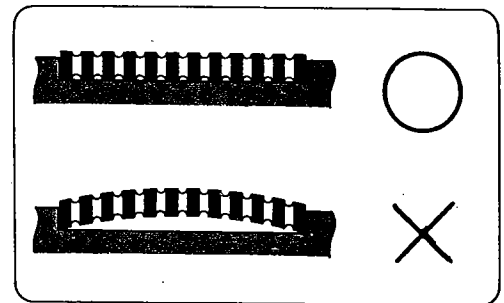
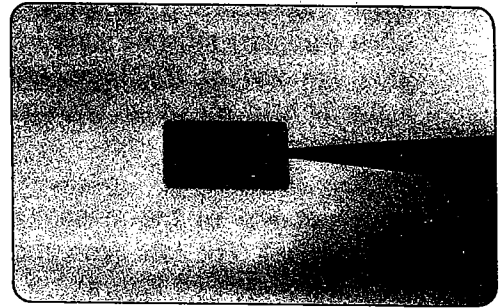

7-1. TROUBLESHOOTING AND ADJUSTMENT FOR WATCH

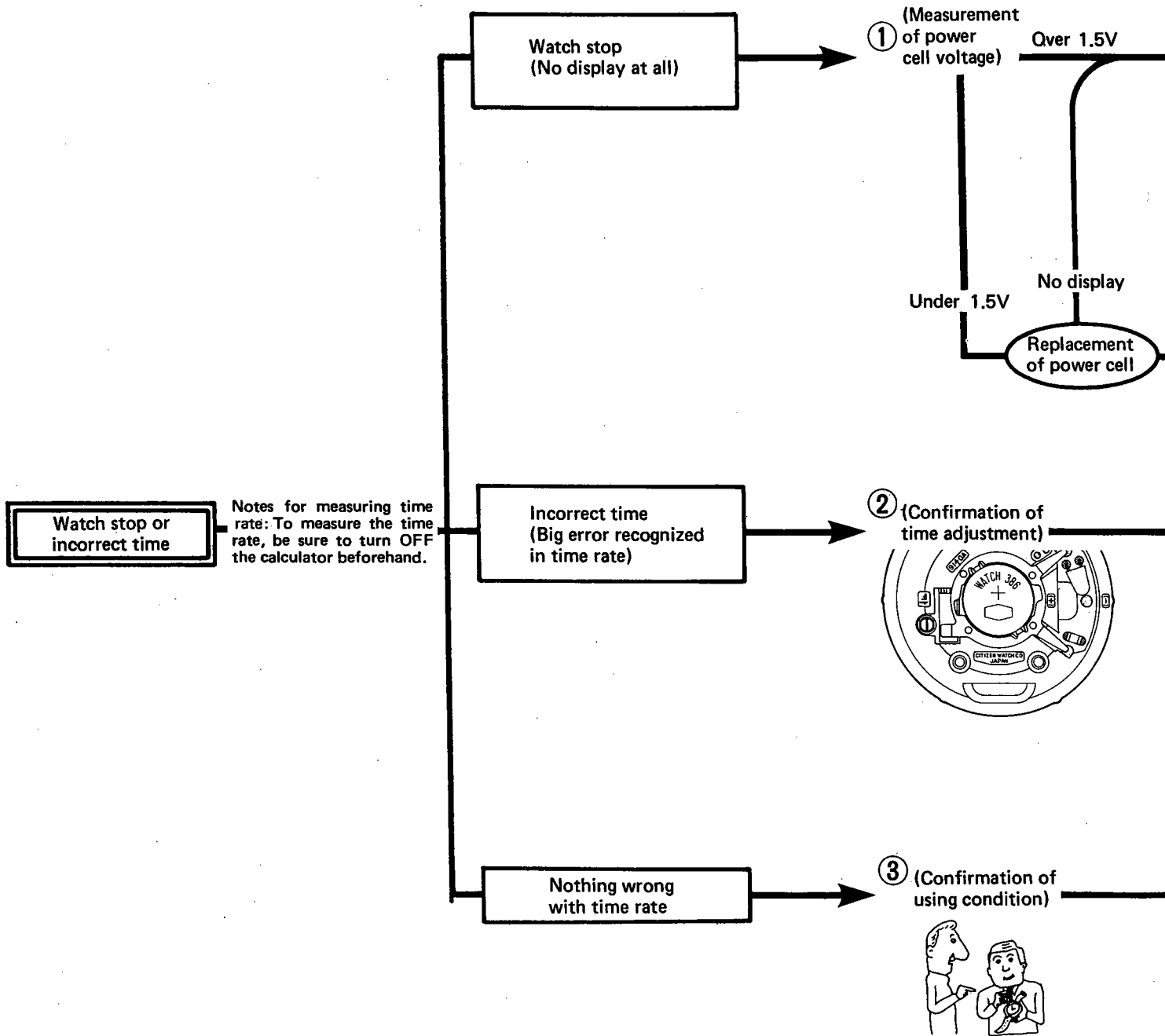

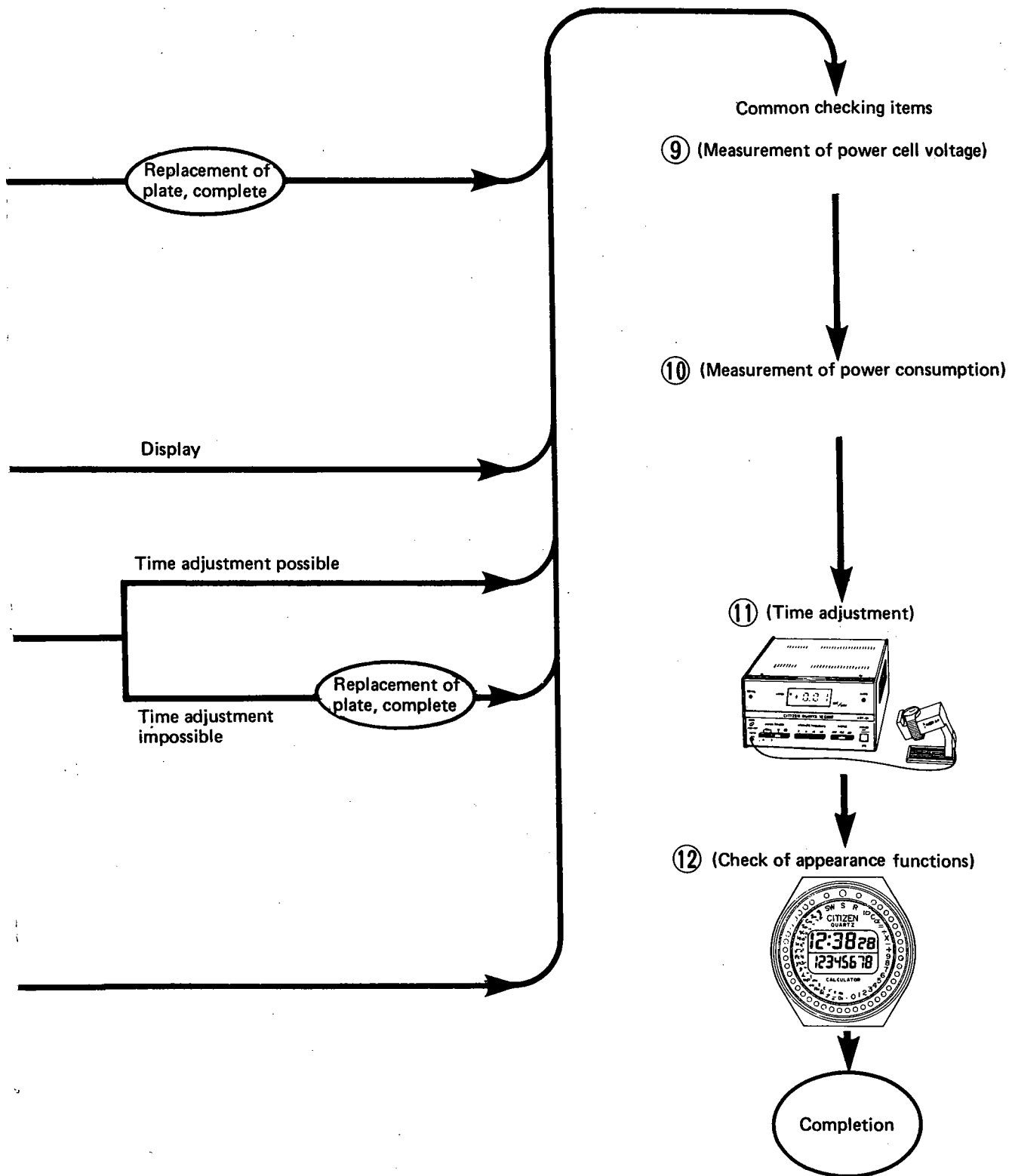

Incomplete functioning of display mechanisms

Segment invisible partially

④ (Check of LC display panel connection section)



Incomplete functioning of additional mechanisms

Display switching impossible

⑤ (Check of display switching mechanism)

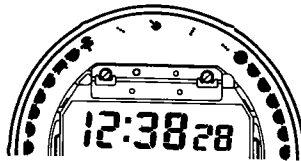
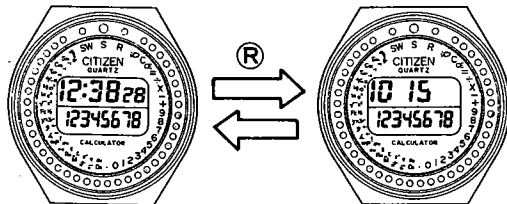

Digit selection impossible for correction of "hour", "minute", "second", "date" and "month"

⑥ (Check of digit selection mechanism)

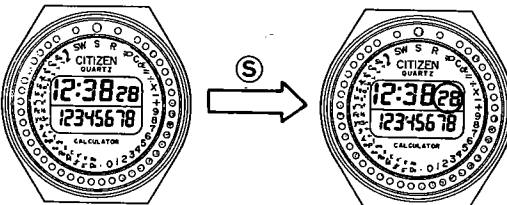

No lamp lighting

⑦ (Check of lamp lighting mechanism)

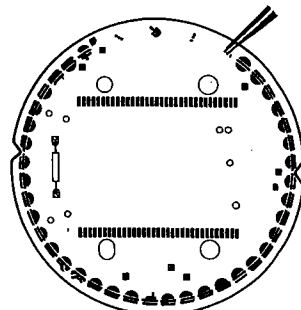

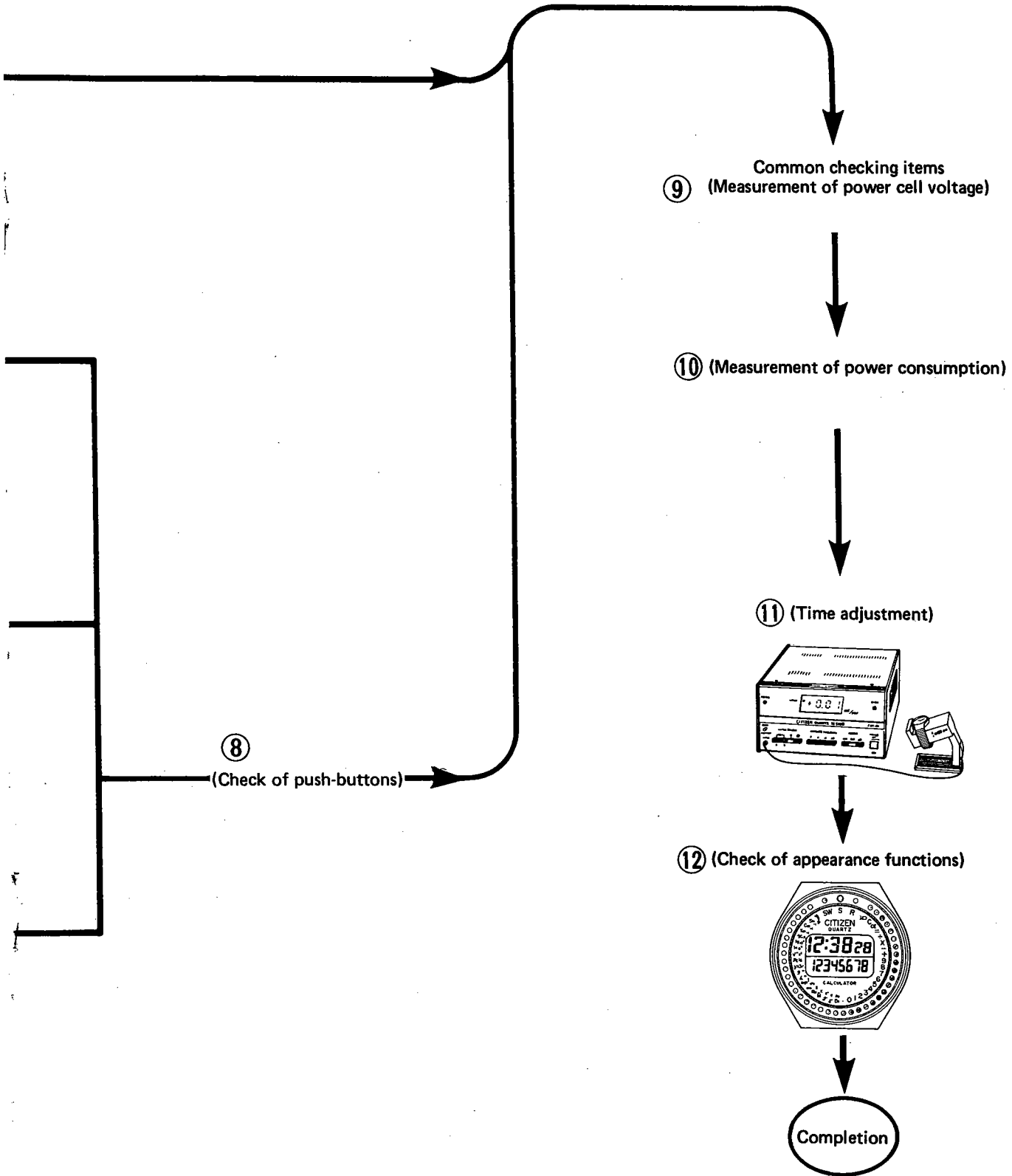

Watch stop – No display at all

1 Measurement of power cell voltage

Power cell voltage : 1.5V

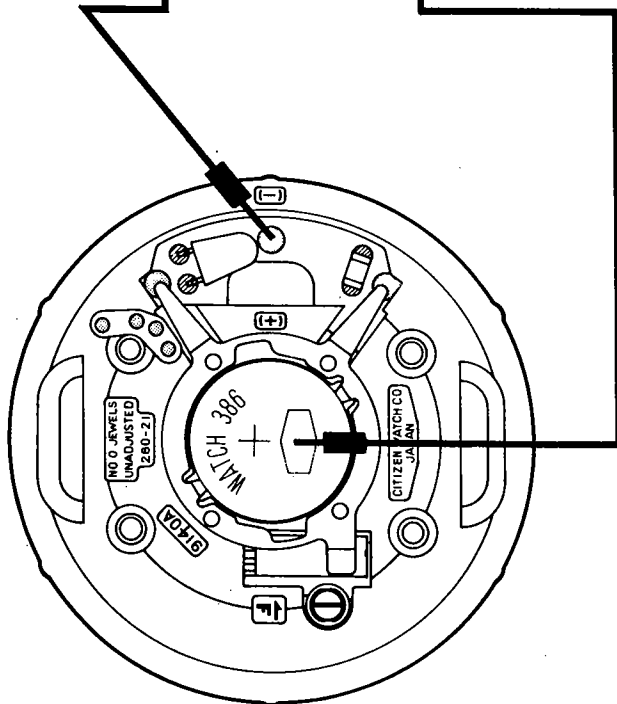
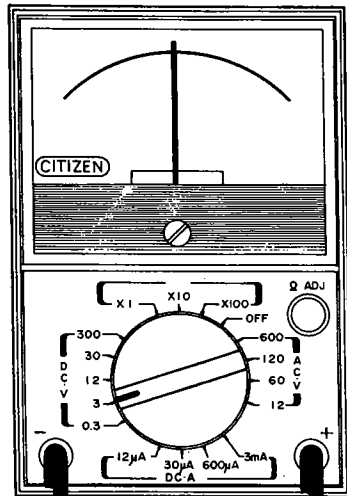

Results and Treatment

Over 1.5V

- Correct display of LC display panel  
→ ⑩ Measurement of power consumption
- No display of LC display panel  
→ Replacement of plate, complete

Under 1.5V

Replacement of power cell:

- Correct display of LC display panel  
→ ⑩ Measurement of power consumption
- No display of LC display panel  
→ Replacement of plate, complete

Note

If the watch has been used more than three years, replace the power cell with new one even if it shows more than 1.5V output power.

How to Put in Power Cell

When installing the power cell into the watch, make the minus (-) side face down.

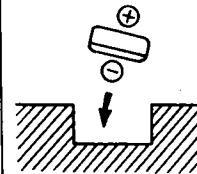

Big error recognized in time rate.

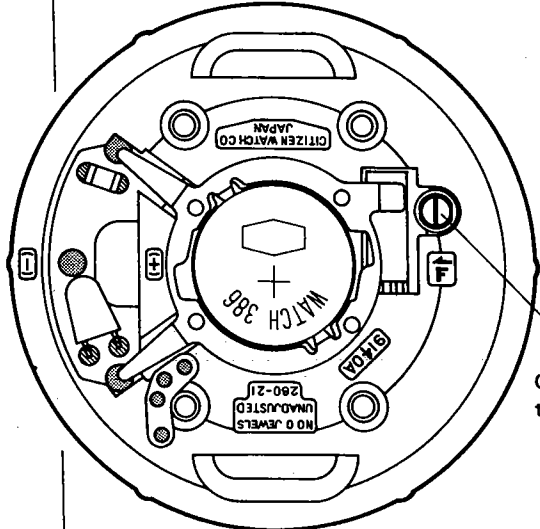
| Check items                                   | How to check  | Results | Treatment  |
|---|---|---------|--|
| <p>2 Confirmation of time rate adjustment</p> | <p>As for the cause of the incorrect time (big error), it is considered that the quartz crystal oscillator attached to the plate has a big error in its frequency. Conduct check by the following procedure.</p> <ol style="list-style-type: none"> <li>1. Check whether time adjustment is possible by the trimmer condenser</li> </ol>  <p>Operation plate of trimmer condenser</p> <ol style="list-style-type: none"> <li>2. The time adjustment is well possible by the trimmer capacitor.</li> <li>3. In case the time adjustment is impossible by the trimmer capacitor, the quartz crystal oscillator has some defects.</li> </ol> <p><b>Notes for measuring time rate:</b><br/>To measure the time rate, be sure to turn OFF the calculator beforehand.</p> |         | <p>Common checking items</p> <p>Replacement of plate, complete</p> |

Nothing wrong recognized in time rate

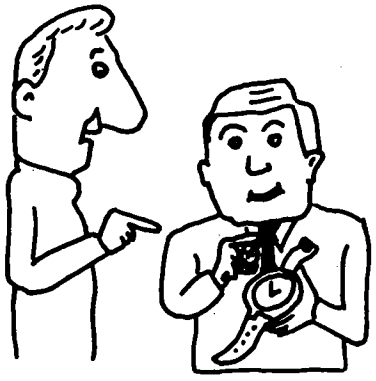
| Check items                              | How to check  | Results | Treatment |
|--|---|---------|-----------|
| <p>3 Confirmation of using condition</p> | <p>Check how the customer has used the watch.<br/>watch.<br/>Ex. Aren't there any mistakes in handling the watch?</p>  |         |           |

Incomplete functioning of display mechanism – Segment invisible partially

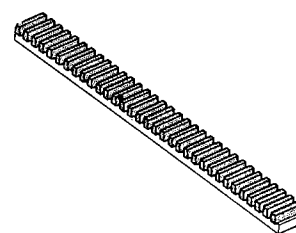
| Check items   | How to check  | Results   | Treatment  |
|---|---|---|--|
| <p>4 Check of LC display panel connection section</p> | <p>For the cause of segment invisible partially, 2 factors are conceivable: the contact is unstable between the LC display panel and the electronic circuit; and the electronic circuit has some defects. However, the former may be more in cases, so conduct a check placing major emphasis on the contact sections.</p> <p>1. Check the screws for LC display panel holder and its related mechanism.</p> <p>(1) Aren't there any broken screws?<br/>(2) Aren't there any loosened screws?<br/>(3) Is the LC display panel holder holding the LC display panel evenly?</p> <p>2. Check the LC display panel connection rubber for electrical contact.</p> <p>(1) Isn't it twisted?<br/>(2) Isn't the rubber worn out or extremely stretched out?<br/>(3) Aren't dust or stains attached on the rubber?</p>  <p>LC display panel connection rubber</p> | <p>Screws broken →</p> <p>Screws loosened →</p> <p>LC display panel held unevenly →</p> <p>Rubber twisted →</p> <p>Rubber worn out →</p> <p>Dust or stains attached →</p> | <p>Replace broken screws with tight fastening.</p> <p>Retightening.</p> <p>Reassembly</p> <p>Replacement</p> <p>Replacement</p> <p>Removal</p> |



| Check items | How to check   | Results   | Treatment  |
|-------------|--|---|--|
|             | <p>3. Referring the illustration below, check the LC display panel's electrode sections of segment invisible whether or not there are any dust or stains.</p> <div data-bbox="446 451 950 892" style="text-align: center;"> <p>Electrode section</p> </div> <p><b>Check points</b><br/>           One quick way to check the segment partial invisible is to push softly around the segment-broken area as shown in the picture below. In this instance, if the broken segment is displayed again, it is clear that the trouble is in the unstable contact.<br/>           In such a case, replace the LC display panel connection rubber for electrical contact.</p> <div data-bbox="430 1291 982 1690" style="text-align: center;"> </div> <p><b>Note:</b> Be careful not to push the LC display panel too strongly since it will break the glass.</p> | <p>Dust or stains attached →</p> <p>Nothing wrong perceived →</p> | <p>Removal</p> <p>Replace LC display panel, even after which trouble is not solved.<br/>           → Replacement of plate, complete.</p> |

Incomplete functioning of additional mechanisms – Display switching impossible

| Check items                                   | How to check  | Results   | Treatment   |
|---|---|---|---|
| <p>5 Check of display switching mechanism</p> | <p>In case the display switching is impossible from "hour" "minute" and "second" to "date" and "month", the following reasons may be considered.</p> <p>(1) Incomplete contact and operation in switching mechanism (push-buttons)<br/>                     (2) Some troubles with the electronic circuit</p> <p>For the above, incomplete contact in switching mechanism may be the cause in most cases. Therefore, check the switching mechanism.</p> <p>1. Take out the movement from the case, apply a pair of metal tweezers simultaneously across both sides of pattern corresponding to the Ⓡ button and check if the display changes over from "hour", "minute" and "second" to "date" and "month".</p> | <p>Display switching possible</p> <p>Display switching impossible</p> | <p>No trouble with electronic circuit<br/>                     Ⓡ Check of push-buttons</p> <p>Some troubles with electronic circuit<br/>                     → Replacement of plate, complete</p> |

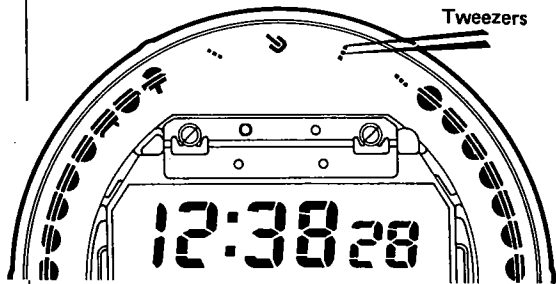

**Incomplete functioning of additional mechanisms – Digit selection impossible for correction of "hour", "minute", "second", "date" and "month"**

| Check items                                 | How to check  | Results  | Treatment   |
|---|---|--|---|
| <p>6 Check of digit selection mechanism</p> | <p>In case the digit selection by flashing is impossible at the normal time display state from "second" to "minute", "hour", "month" and to "date", the following factors must be taken into consideration.</p> <p>(1) Incomplete contact at switching point<br/>(2) Some troubles with electronic circuit</p> <p>As (1) is usually considered as the main reason, conduct check for the switching point in the same checking way as stated in the preceding section ⑤.</p> <div data-bbox="407 814 954 1205" style="text-align: center;"> </div> | <div style="text-align: center;"> </div> <p>Digit selection possible →</p> <p>Digit selection impossible →</p> | <p>No trouble with electronic circuit<br/>→ ⑧ Check of push-buttons</p> <p>Some troubles with electronic circuit<br/>→ Replacement of plate, complete</p> |

Incomplete functioning of additional mechanisms – No lamp lighting

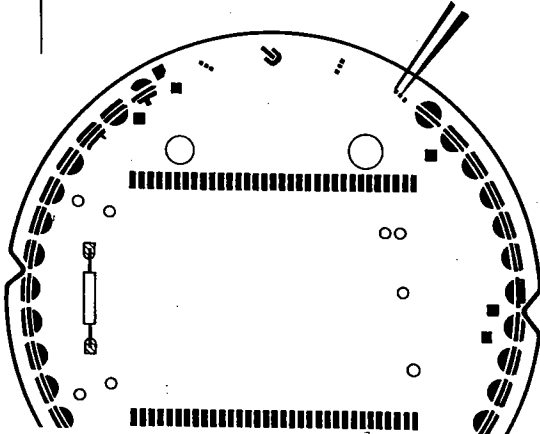
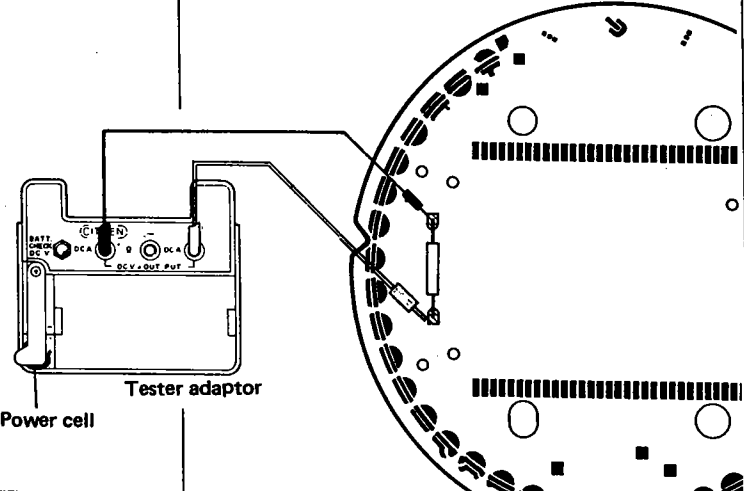
| Check items                               | How to check   | Results   | Treatment   |
|---|--|---|---|
| <p>7 Check of lamp lighting mechanism</p> | <p>As for the reason of the fact that the illumination lamp does not light, the following two factors may be considered.</p> <p>(1) Incomplete contact at the switching point<br/>(2) Some defects in lamp itself</p> <p>In this respect, conduct check for the above two factors as follows.</p> <p>1. Take out the movement from the case, apply a pair of metal tweezers simultaneously across both sides of pattern corresponding to the (L) button and check if the lamp lights up.</p>  <p>2. Disassemble the movement and conduct check for the illumination lamp with a single unit of the plate, complete as illustrated below.</p>  | <p>Lamp lighting possible</p> <p>No lamp lighting</p> <p>No lamp lighting</p> | <p>No trouble with lamp itself<br/>⑧ Check of push-buttons</p> <p>2. Check of lamp itself</p> <p>Replacement of plate, complete</p> |

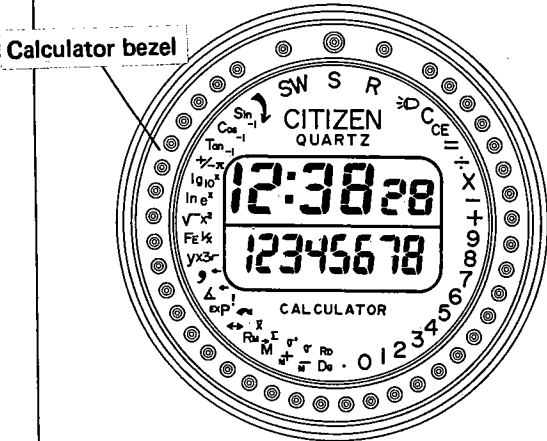
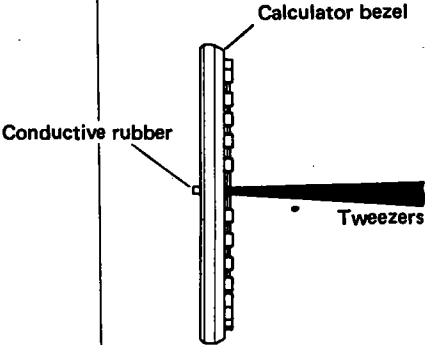
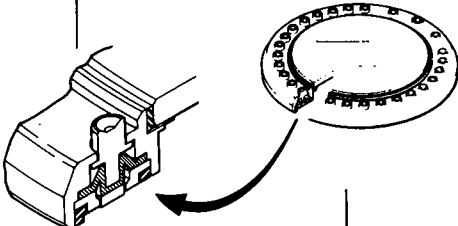
| Check items                    | How to check   | Results  | Treatment  |
|--------------------------------|--|--|--|
| <p>8 Check of push buttons</p> | <p>When nothing wrong is found in the electronic circuit, the push-button may be out of order.</p> <p>(1) Fully push the each button so that its top surface becomes flush with the name plate surface and check if the conductive rubber is pushed to protrude to the other side.</p> <p>(2) Check if any dust or non-conductive foreign object adhered to the conductive rubber.</p>    | <p>No protrusion of rubber</p> <p>Dust or foreign object adhered</p> | <p>Replacement of calculator bezel.</p> <p>Removal</p> |

Common checking items

9 Measurement of power cell voltage

Power cell voltage : Over 1.5V

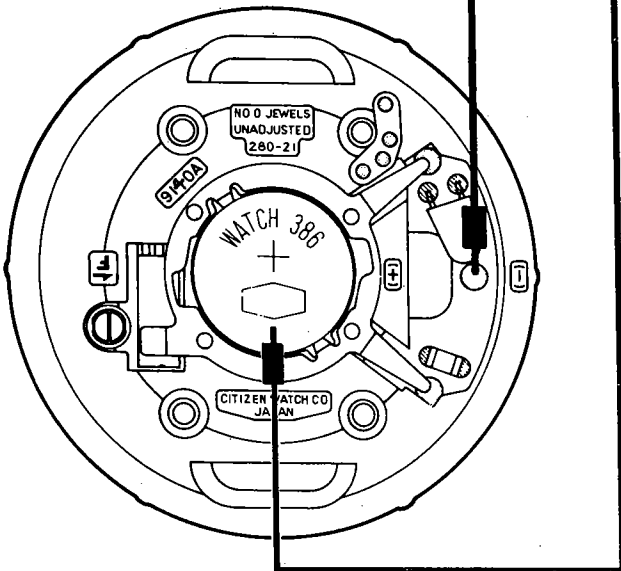
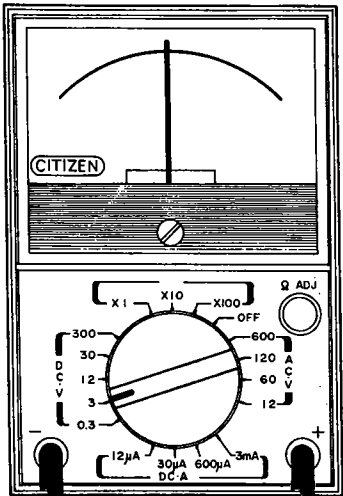

Results and Treatment

Over 1.5V

- Correct display of LC display panel  
→ ⑩ Measurement of power consumption
- No display of LC display panel  
→ Replacement of plate, complete

Under 1.5V

- Replacement of power cell:
- Correct display of LC display panel  
→ ⑩ Measurement of power consumption
  - No display of LC display panel  
→ Replacement of plate, complete

Note

If the watch has been used more than three years, replace the power cell with new one even if it shows more than 1.5V output power.

How to Put in Power Cell

When installing the power cell into the watch, make the minus (-) side face down.

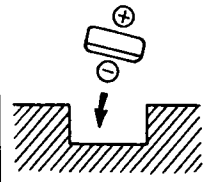

10 Measurement of power consumption

(FOR WATCH)

Power consumption : Under  $4.0\mu\text{A}$

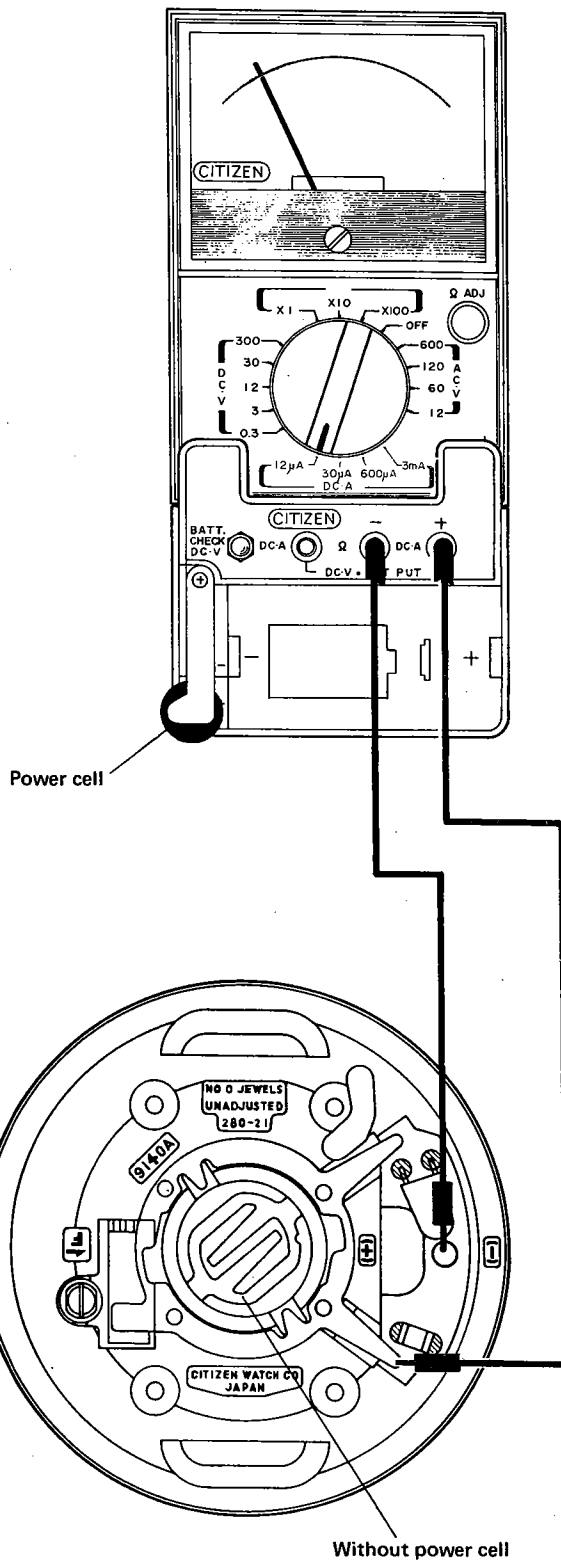

**Result and Treatment**

1) Measurement under the normal condition:

**Under  $4\mu\text{A}$**

→ ① Time adjustment

**Over  $4\mu\text{A}$**

→ 2) Measurement of power consumption of electronic circuit

2) Measurement of power consumption at electronic circuit with LC display panel removed.

**Under  $2\mu\text{A}$**

→ Replacement of LC display panel connector or LC display panel

**Over  $2\mu\text{A}$**

→ Replacement of plate, complete

**Note**

Install a power cell of more than 1.5V into the power cell holder of the adaptor.

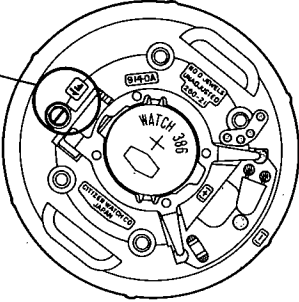
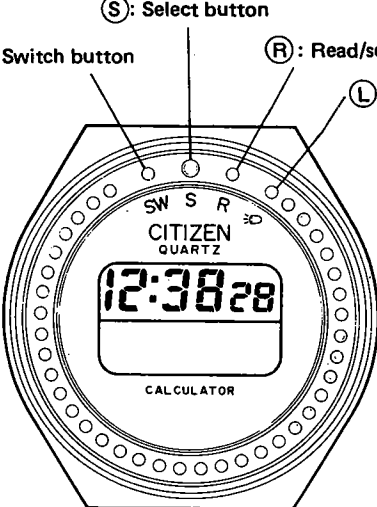
| Check items                             | How to check   | Results   | Treatment |
|---|--|---|-----------|
| <p>11 Time adjustment</p>               | <p>Conduct measurement of time rate using a timing machine and confirm time adjustment.</p>  <p>Trimmer condenser</p>   | <p>The time adjustment can be performed by turning right and left the operation plate of trimmer capacitor.</p> |           |
| <p>12 Check of appearance functions</p> | <p>Finally, conduct check and adjustment for the appearance functions as follows.</p> <ol style="list-style-type: none"> <li>1) Make sure the displayed figures have no trouble at all.</li> <li>2) Make sure each of the push-button is correctly functioning for the display switching/correction, lamp lighting, etc.</li> <li>3) Check for the calculator is working correctly by pressing buttons.</li> </ol>  <p>             (S): Select button<br/>             (SW): Switch button<br/>             (R): Read/set button<br/>             (L): Light button         </p> |   |           |



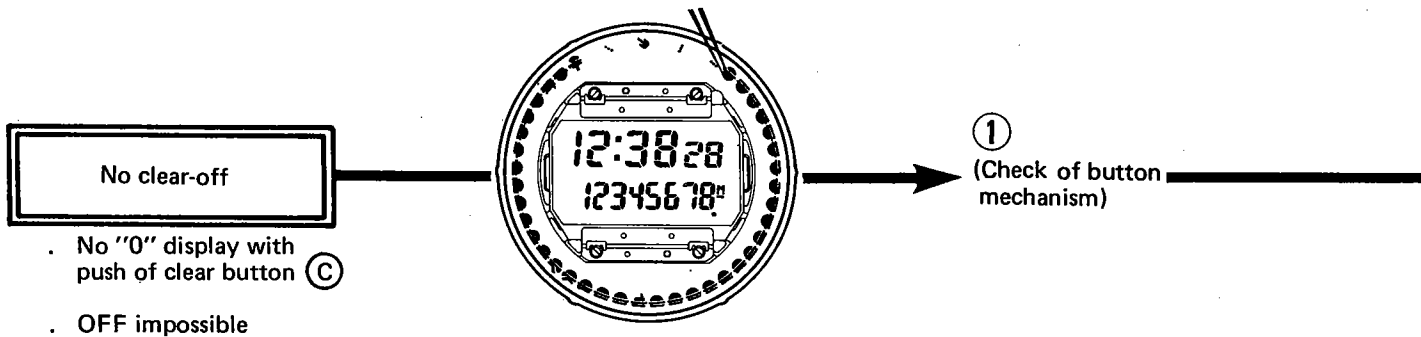
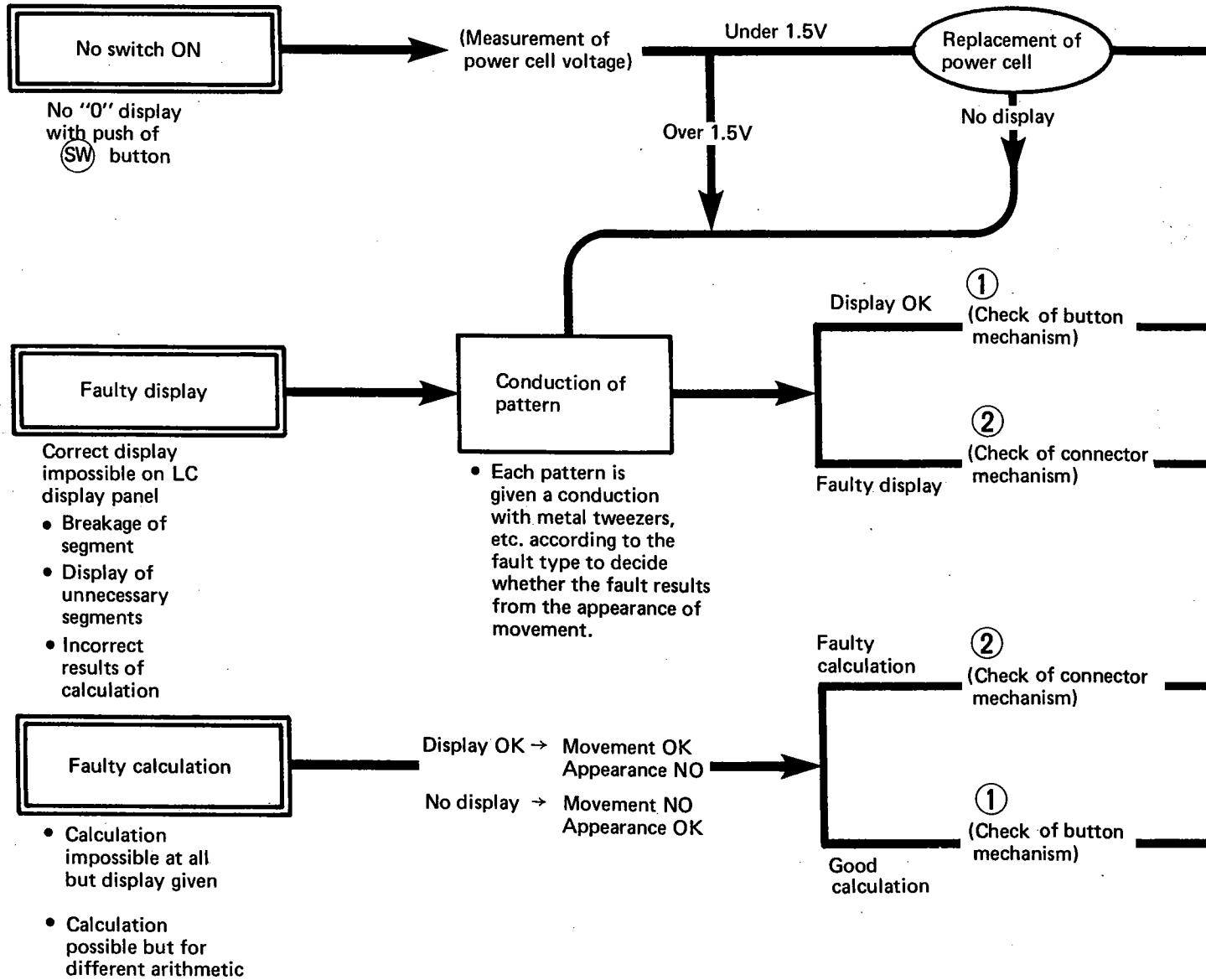

7-2. TROUBLESHOOTING AND ADJUSTMENT FOR CALCULATOR



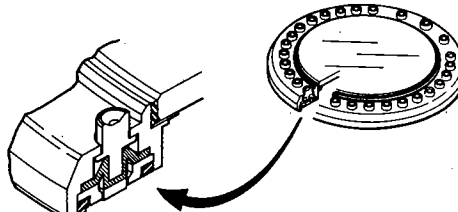
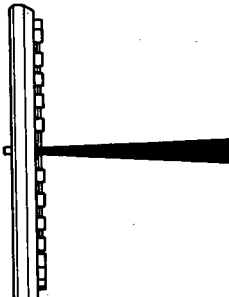

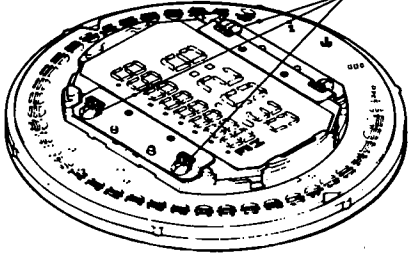
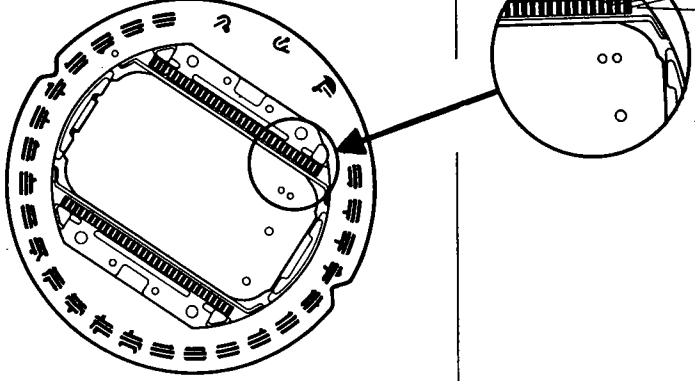
| Check items                        | How to check  | Results   | Treatment  |
|------------------------------------|---|---|--|
| <p>1 Check of button mechanism</p> | <p>Have a check for the button mechanism in a state of the bezel complete.</p> <p>1. Check whether any dust or insulator materials stick to the conduction rubber part.</p>  <p>2. Confirmation of button operation</p> <p>In a state of single unit of the bezel complete, push the push-button until it reaches the same level of the name plate surface, and check whether the protrusion of the conduction rubber can be viewed at the opposite side.</p>  <p>Conduction rubber must be viewed.</p> <p>Calculator bezel</p> | <p>Dust or insulator materials stucked →</p> <p>No abnormality →</p> <p>Rubber viewed →</p> <p>No rubber viewed →</p> | <p>Removal</p> <p>Work of 2.</p> <p>Check for connector mechanism</p> <p>Replacement of calculator bezel</p> |

| Check items                           | How to check  | Results  | Treatment   |
|---------------------------------------|---|--|---|
| <p>2 Check of connector mechanism</p> | <p>The following points must be checked.</p> <p>1. Check whether the screws for the LC display panel holder have any loosening or breakage.</p> <p style="text-align: center;">Screw for LC display panel holder</p>  <p>2. Check whether any pitch discrepancy exists between the plate pattern and the auxiliary rubber for electrical contact.</p>  <p>3. Check whether any pitch discrepancy exists between the LC display panel and the auxiliary rubber for electrical contact.</p> <p>4. Check whether any dust or insulator materials stick to the plate pattern, electrode part of LC display panel, auxiliary rubber for electrical contact and others.</p> | <p>Screws loosening →</p> <p>Screws breakage →</p> <p>Pitch discrepancy →</p> <p>Dust or insulator materials stuck →</p> | <p>Tightening</p> <p>Replacement of screws</p> <p>Reassembly or replacement contact rubber</p> <p>Removal</p> |
| <p>3 Check of pattern part</p>        | <p>1. In case no "0" is displayed even with push of clear button (C), check whether any dust or iron filings, etc. stick to the plate pattern part.</p> <p>2. Have the same check in case the display does not disappear even with push of switch button (SW)</p>    | <p>Dust or iron filings stuck →</p>  | <p>Removal</p>  |

4 Measurement of power cell voltage

Power cell voltage : 1.5V

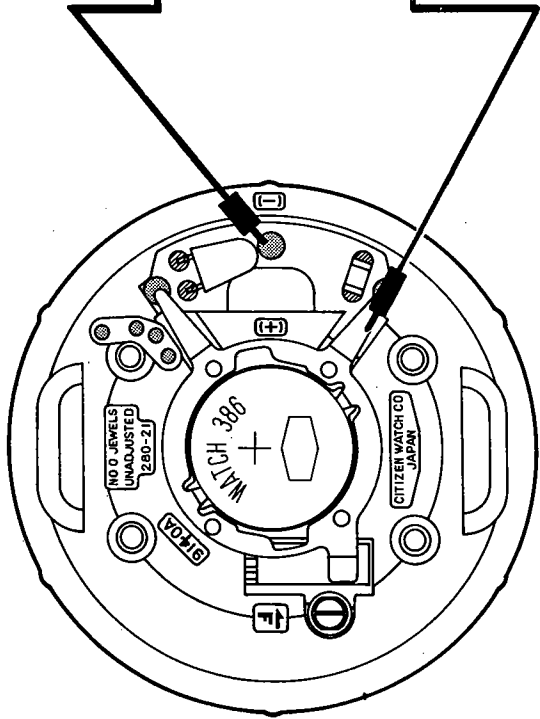
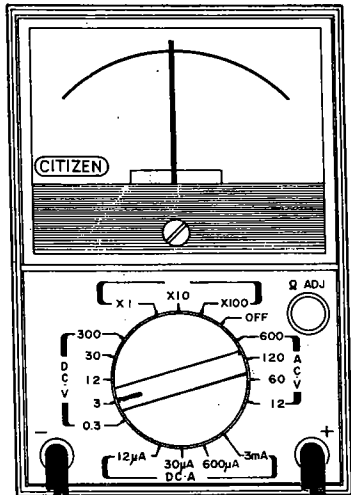

**Results and Treatment**

**Over 1.5V**

- Correct display of LC display panel  
→ ⑤ Measurement of power consumption
- No display of LC display panel  
→ Replacement of plate, complete

**Under 1.5V**

Replacement of power cell:

- Correct display of LC display panel  
→ ⑤ Measurement of power consumption
- No display of LC display panel  
→ Replacement of plate, complete

**Note**

If the watch has been used more than three years, replace the power cell with new one even if it shows more than 1.5V output power.

**How to Put in Power Cell**

When installing the power cell into the watch, make the minus (-) side face down.

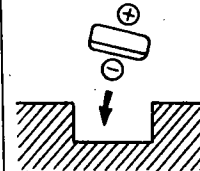

5 Measurement of power consumption

(FOR CALCULATOR)

Power consumption : Under  $180\mu\text{A}$

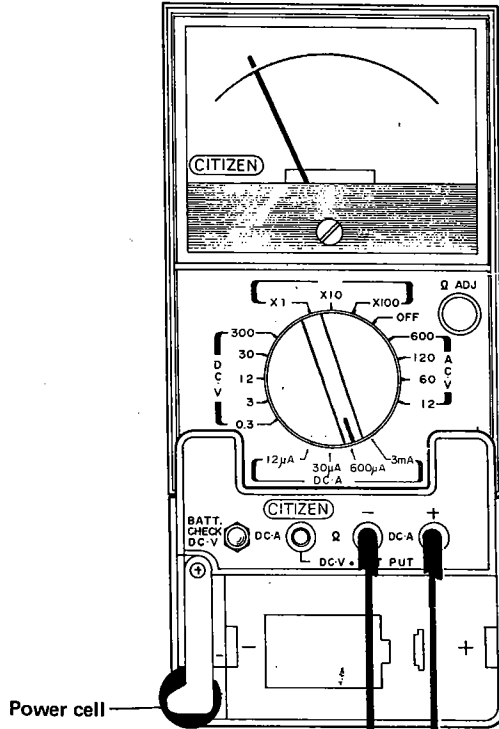

**Result and Treatment**

Measure the power consumption in a state under which the switch is ON and "0" is displayed.

**Under  $180\mu\text{A}$**

→ ⑥ Check of appearance functions

**Over  $180\mu\text{A}$**

→ Replacement of plate, complete

**Note**

Put in two units of power cell (1.5V or more) in series into the power cell holder of the adaptor.

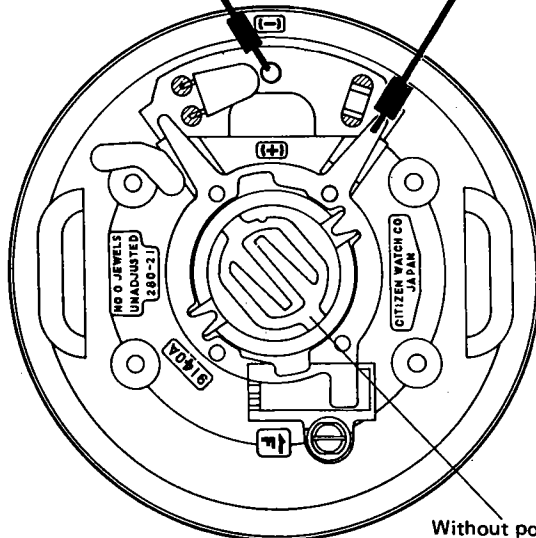

Without power cell



**CITIZEN WATCH CO., LTD.**  
Tokyo, Japan